

LUXMO I LED STREET LIGHT

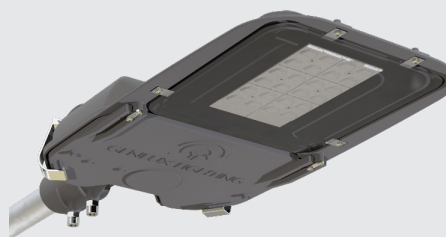

Product Variations

Type	Driving Current	Typical Power	Luminous Flux	
	(mA)	(W)	(lm) Nominal	(lm) Effective
2x6	300	23	3 800	3 150
	400	31	4 950	4 100
	500	39	6 050	5 050
	600	47	7 100	5 900
	700	55	8 150	6 750
4x6	300	43	7 400	6 150
	400	58	9 700	8 050
	500	72	12 150	9 800
	600	90	14 250	11 550
	700	107	16 250	13 150

Optics

Optic: 41800

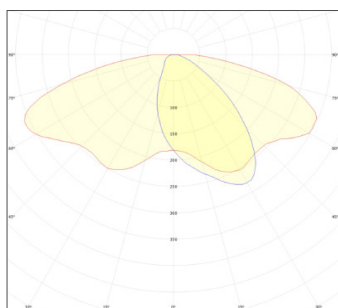

Optic: 41801

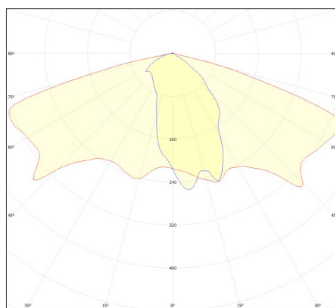

Optic: 41802

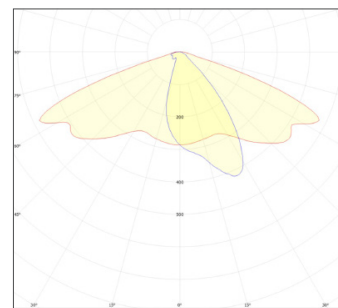

Optic: 41803

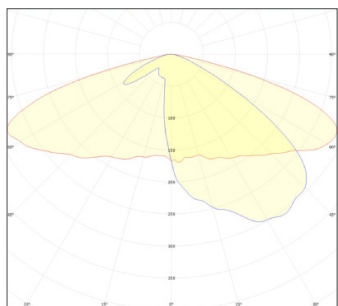

Optic: 41804

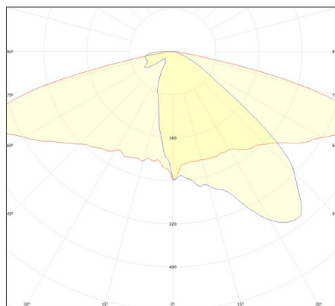

Optic: 41805

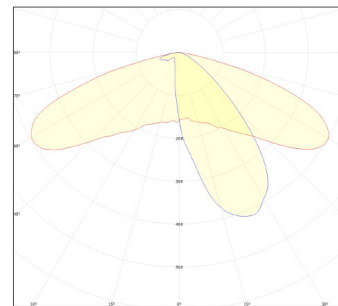

Product Information

Design		
Manufacturing	Locally designed and manufactured	
Luminaire and control gear housing	High-pressure die-cast LM6 aluminum finished with polyester epoxy powder coating.	
Clips and fasteners	304 Grade stainless steel	316 Grade stainless steel *
Diffuser	4mm clear tempered glass	High impact PC *
Optics	Optical grade acrylic (PMMA) Zhaga "Book 15" compliant lenses	
Colour	Unpainted standard	Painted grey or other colours *
Mounting options	Rear / Side spigot entry tapering from 45mm to 42mm Ø Spigot mounting depth 125mm	

Technical Data		
Luminaire Compliance standards	SANS / IEC 60598-2-3	
Surge protection	6+10kV / 10+10kA	
Power supply	220V to 240V AC 50/60 Hz	
Power factor	0.98	
Insulation protection	Class 1	
Weight	6.3 kg	
Windage area	0.039 m ²	
Lifetime	Luminaire	Up to 20 year on luminaire body Up to 7 year on internal components

*Available on request

Lighting Data			
Design life	up to 100 000 hours		
Typical lumen maintenance	L90 @ >100 000 hours		
CRI	70	80 *	
Light Output Ratio (LOR)	up to 85%		
Colour Temperature	3000K *	4000K	5000K *
Operating temperature	-30°C to 45°C		
Dimmable	1-10V *	DALI *	D4i *

Dimensions

Luxmo I

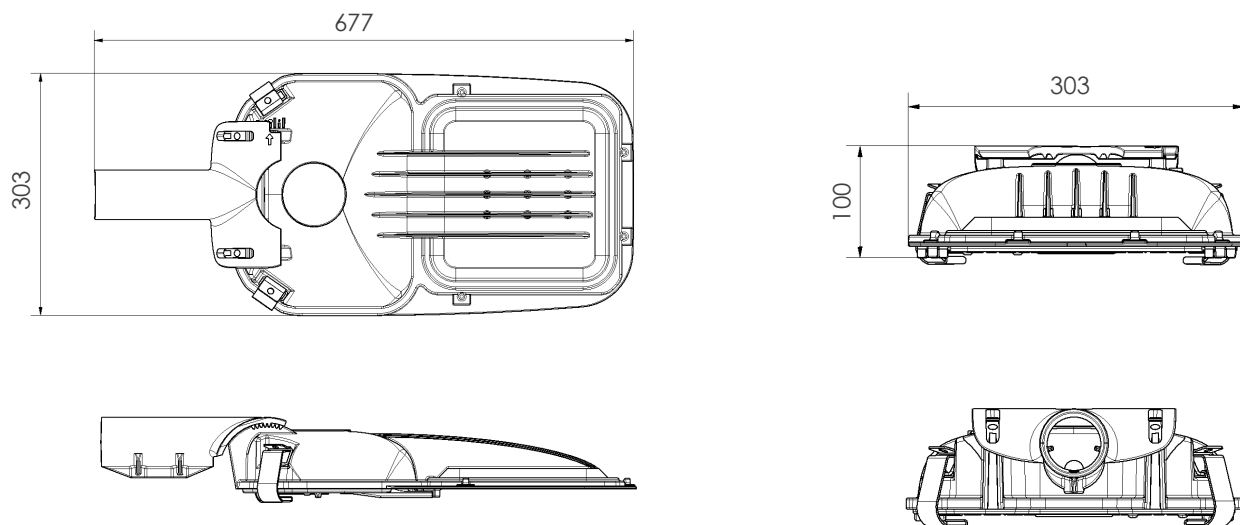

Disclaimer

Due to the rapid development in LED technology the performance values, power consumption and lumen output levels stated above are subject to change without prior notice. For any requirements not covered in the above variations please contact us for a customized solution.

IMPORTANT NOTES

- (1) Measurement precision for flux +/- 5%, for efficacy +/- 6%, for CRI +/- 1.5
- (2) Lumen maintenance L90 = 90% of initial flux @ 1a 35°C / 100 000hrs

Technical changes and printing errors reserved • Errors and Omissions Excepted

JOHANNESBURG (HQ)

4 Branch Rd, Driehoek, Germiston, 1401
P.O. Box 1183 Germiston
Tel: +27 (0)11 825 3144/5
genluxsales@actom.co.za

BLOEMFONTEIN

20 Lombard Street, Hilton, Bloemfontein, 9300
P.O. Box 914, Bloemfontein, 9300
Tel: +27 (0)51 448 1417
Email: genluxsales@actom.co.za

CAPE TOWN

12 Hawkins Avenue, Epping Industria No 1, 7460
P.O. Box 276, Eppindust, Cape 7475
Tel: +27 (0)21 532 2000
genluxCT@actom.co.za

DURBAN

70 Solomon Mahlangu Drive, Rossburgh 4094
P.O. Box 922, Durban 4000
Tel: +27 (0)31 465 4170
genluxKZN@actom.co.za

GQEBERHA

200 Kempston Road, Sidwell, Gqeberha 6001
P.O. Box 3503, North End, Gqeberha 6056
Tel: +27 (0)41 451 5641
genluxPE@actom.co.za



www.genluxlighting.co.za
011 825 3144
genluxsales@actom.co.za

GENLUX LIGHTING
a lighting technology company