



GENLUX LIGHTING

a lighting technology company

GEN I LED STREETLIGHT



GENERAL TECHNICAL DATA & WARRANTY INFORMATION

Typical applications:	<ul style="list-style-type: none"> • Class A Roadway lighting • Class B Roadway lighting • Parking areas • Commercial areas • Residential areas
Light source:	High powered LED Modules
Colour temperature:	<ul style="list-style-type: none"> • 3000K* • 4000K • 5000K*
Operating temperature range:	-30°C to 45°C
Relative humidity:	Operational: 5% to 95%
	Storage: 10% to 90%
Design life:	100 000 hours
Typical Lumen maintenance:	Up to L90 @ 100 000 hours
IP Rating:	IP66 (Lamp and gear compartment)
Luminaire housing:	High-pressure die-cast LM6 aluminum finished with a durable dark grey* polyester epoxy powder coating. [*Grey is the standard colour, unpainted or other colours available on request]
Luminaire clips and fasteners:	<ul style="list-style-type: none"> • 304 Grade stainless steel • 316 Grade stainless steel*
Diffuser:	<ul style="list-style-type: none"> • 4mm Clear tempered glass diffuser • High impact PC diffuser*
Optics:	Optical grade acrylic (PMMA) Zhaga book 15 compliant lenses
Impact protection grade:	IK08
Mounting options:	<ul style="list-style-type: none"> • Rear / Side spigot entry tapering from 45mm Ø to 42mm Ø • Spigot mounting depth 125mm
Windage area:	0.095m ²
Dimmable:	1-10V* DALI* D4i*
Surge protection:	10+10kV / 10+10kA
Power supply:	220V to 240V AC 50/60 Hz
Power factor:	0.98
Insulation classification:	Class 1
Compliance standard/s:	<ul style="list-style-type: none"> • SANS / IEC 60598-2-3 • SANS 475

[*Available on request]



GEN I LED STREETLIGHT

DIMENSIONS

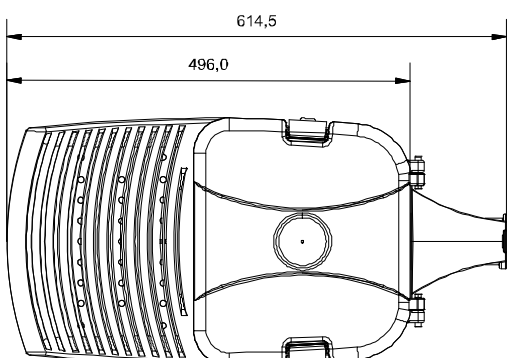
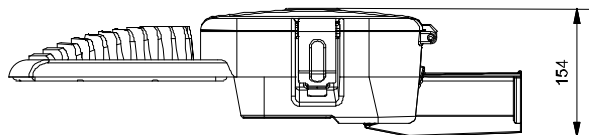
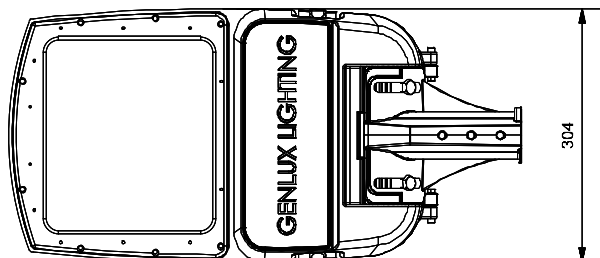

TYPICAL LIGHT DISTRIBUTION OPTIONS

- POLAR DIAGRAMS

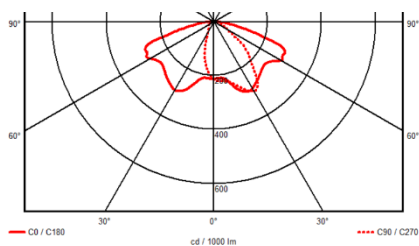

Optic: 41800

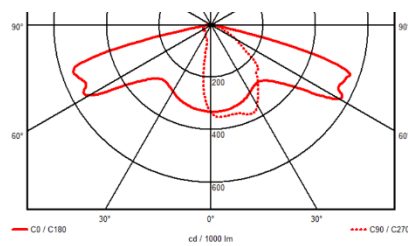

Optic: 41801

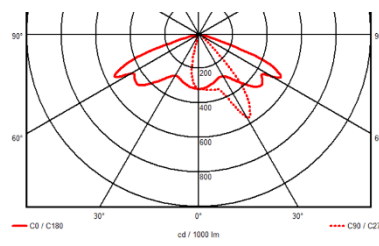

Optic: 41802

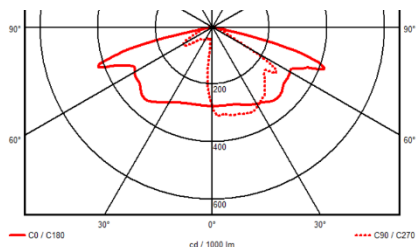

Optic: 41803

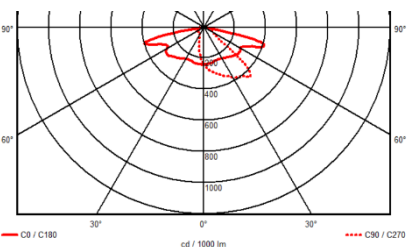

Optic: 41804

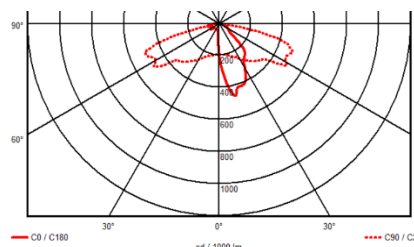

Optic: 41805

- For best light distribution option please request a lighting design for specific application.



GEN I LED STREETLIGHT

PRODUCT VARIATIONS & ORDERING CODES

Variation	Driving Current (mA)	Nominal Luminous flux *1 (lm)	Effective Lumen output *1 (lm)	Typical Power Consumption (W)	CRI *1 / *3	Lumen Maintenance *2	Weight (Kg)
GEN I SL 1	350	4 140	3 312	25	70	L90	10.0
	400	4 640	3 712	30			
	520	5 840	4 672	40			
	700	7 640	6 112	56			
GEN I SL 2	350	8 280	6 624	51			
	425	10 256	8 205	64			
	530	11 680	9 504	80			
	620	13 680	10 944	98			
	700	15 250	12 224	111			
GEN I SL 3	350	12 420	9 936	76			
	520	17 520	14 016	120			
	600	21 012	16 809	138			
GEN I SL 4	505	22 760	18 208	155			

KEY's & IMPORTANT NOTES

(*1) Measurement precision for flux +/- 5%, for efficacy +/- 6%, for CRI +/- 1.5

(*2) Lumen maintenance L90 = 90% of initial flux @ ta 35°C / 100 000hrs

(*3) 80 CRI available on request

- **E.&O.E.** (errors and omissions excepted)
- **Important notes:**
 - Due to the rapid development in LED technology the performance values, power consumption and lumen output levels stated above are subject to change without prior notice.
 - For any requirements not covered in the above variations please contact us for a tailored solution



GENLUX LIGHTING

a lighting technology company

GEN I LED STREETLIGHT

Email: genluxsales@actom.co.za

Tel: +27 11 825-3144

Website: www.genluxlighting.co.za