



GENLUX LIGHTING

a lighting technology company



GENERAL TECHNICAL DATA & WARRANTY INFORMATION

Typical applications:	<ul style="list-style-type: none"> • General area lighting • Parking area lighting • High mast lighting 				
Light source:	High powered LED Modules				
Colour temperature:	<ul style="list-style-type: none"> • 3000K* • 4000K • 5000K* [*Available on request]				
Operating temperature range:	-30°C to 45°C				
Relative humidity:	<table border="0"> <tr> <td>Operational:</td> <td>5% to 95%</td> </tr> <tr> <td>Storage:</td> <td>10% to 90%</td> </tr> </table>	Operational:	5% to 95%	Storage:	10% to 90%
Operational:	5% to 95%				
Storage:	10% to 90%				
Design life:	100 000 hours				
Typical Lumen maintenance:	Up to L90 @ 100 000 hours				
IP Rating:	IP66 (Lamp and gear compartment)				
Luminaire housing:	High-pressure die-cast LM6 aluminum finished with a durable dark grey* polyester epoxy powder coating. [*Grey is the standard colour, unpainted or other colours available on request]				
Luminaire clips and fasteners:	<ul style="list-style-type: none"> • 304 Grade* stainless steel [*316 Grade available on request]				
Diffuser:	<ul style="list-style-type: none"> • 4mm Clear tempered glass diffuser [High impact PC diffuser available on request]				
Optics:	Optical grade acrylic (PMMA) Zhaga book 15 compliant lenses				
Impact protection grade:	IK08				
Mounting options:	Adjustable Stirrup mount				
Windage area:	0.12 m ²				
Dimmable:	1-10V or DALI* [*Available on request]				
Surge protection:	20kV / 20kA				
Power supply:	220V to 240V AC 50/60 Hz.				
Power factor:	0.98				
Insulation classification:	Class 1				
Weight:	15.5 kg – 16.30 kg				
Compliance standard/s:	<ul style="list-style-type: none"> • SANS / IEC 60598-2-5 • SANS 475 				

[*Available on request]



GEN II LED FLOODLIGHT

DIMENSIONS

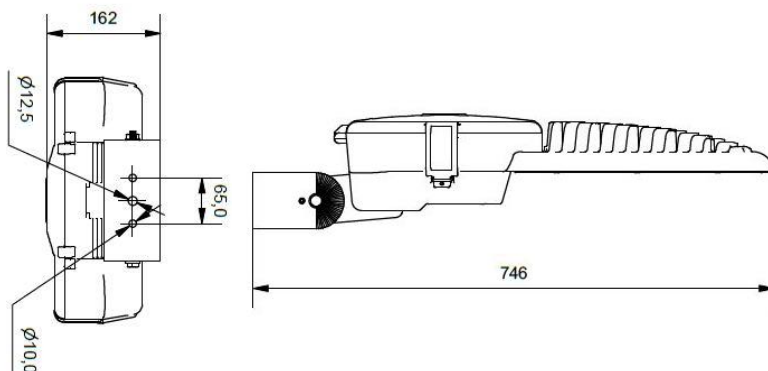
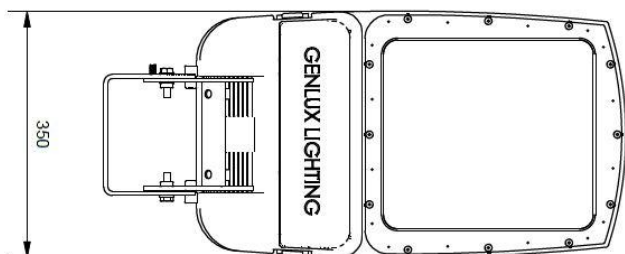

TYPICAL LIGHT DISTRIBUTION OPTIONS

- POLAR DIAGRAMS

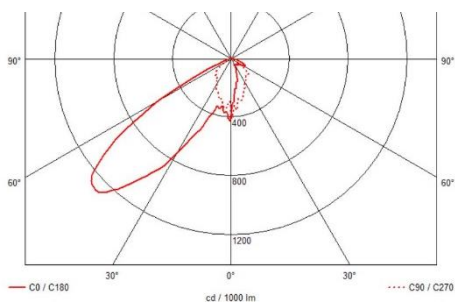

Optic: 41807

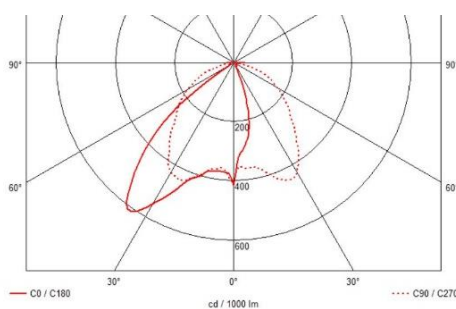

Optic: 41811

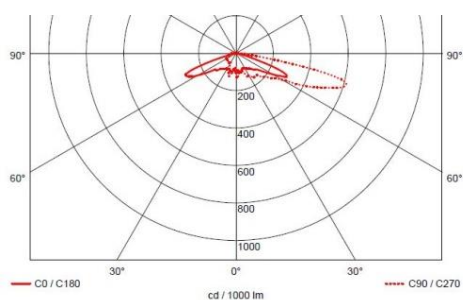

Optic: 41815

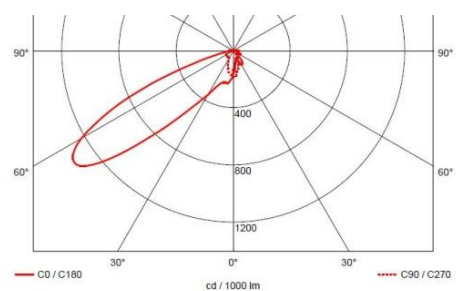

Optic: 41816

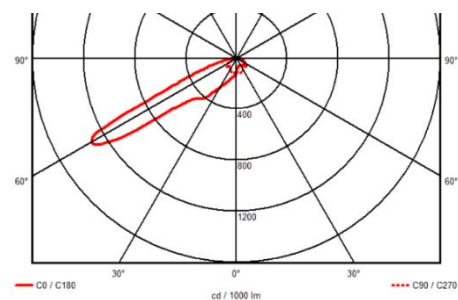

Optic: 41817

- Other light distribution options available on request.
- For best light distribution option please request a lighting design for specific application.



GEN II LED FLOODLIGHT

PRODUCT VARIATIONS & ORDERING CODES

Variation	Driving Current (mA)	Nominal Lumen output *1 (lm)	Effective Lumen output *1 (lm)	Typical Power Consumption (W)	CRI *1 / *3	Lumen Maintenance *2	Weight (Kg)
GEN II FL 3	510	23 816	19 053	155	70	L90	15.5
GEN II FL 4	510	31 755	25 404	206			
	650	39 525	31 620	270			
GEN II FL 5	500	39 000	31 200	252			
	550	41 401	33 212	280			

KEY'S & IMPORTANT NOTES

(*1) Measurement precision for flux +/- 5%, for efficacy +/- 6%, for CRI +/- 1.5

(*2) Lumen maintenance L90 = 90% of initial flux @ ta 35°C / 100 000hrs

(*3) 80 CRI available on request

- **E.&O.E.** (errors and omissions excepted)
- **Important notes:**
 - Due to the rapid development in LED technology the performance values, power consumption and lumen output levels stated above are subject to change without prior notice.
 - For any requirements not covered in the above variations please contact us for a tailored solution